

Profile

- Solid shaft \varnothing 6 mm
- Adaptation to various measurement paths owing to a wide range of gear ratios
- Integrated friction clutch to protect the potentiometer
- Compact design
- Potentiometer or power output
- IP65 protection category possible
- Up to 3 switching cam outputs, freely adjustable

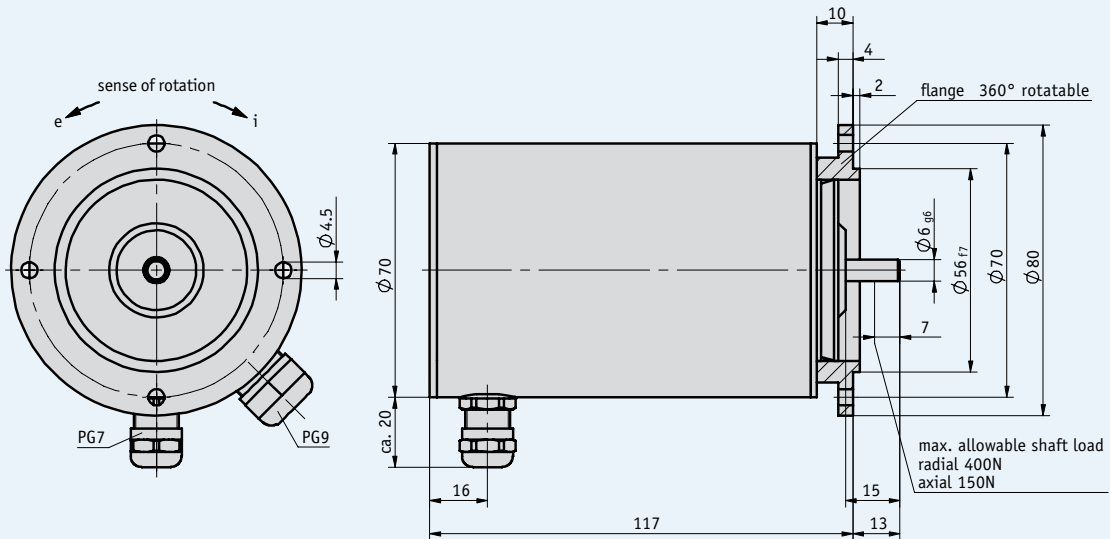

Mechanical data

Feature	Technical data	Additional information
Gear ratio	0.1 ... 512	
Speed	max. 500 rpm	depending on gear ratio
Operating temperature	-20 ... +80 °C	
Condensation	inadmissible	
Service life of axial movement	1 x 10 ⁶ 2 x 10 ⁶	with P01, P02 with P03
Protection category	IP52, IP65	according to DIN VDE 0470
Maximum shaft load	radial 400 N axial 150 N	
Shaft	browned steel, \varnothing 6 mm	
Housing	aluminum	

Electrical data

Feature	Technical data	Additional information
Interference protection class	3	according to IEC 801

Analog outputs

Feature	Technical data	Operating voltage
Potentiometer output	0 ... 1 k Ω , 0 ... 5 k Ω , 0 ... 10 k Ω depending on the potentiometer type used	
Power output	4 ... 20 mA	24 V DC \pm 20 %, with load \leq 500 Ω

Potentiometer type

Feature	01	02	03
Design	hybrid	wire	hybrid
Resistance	1 k Ω , 5 k Ω , 10 k Ω	1 k Ω , 5 k Ω , 10 k Ω	1 k Ω , 5 k Ω , 10 k Ω
Resistance tolerance	\pm 5 %	\pm 5 %	\pm 5 %
Linearity tolerance	\pm 0.25 %	\pm 0.25 %	\pm 0.25 %
Load rating	1 W at 70 °C	1 W at 70 °C	2 W at 70 °C
Range of rotation	340° \pm 5° (mechanically straight-through)	3600° \pm 10°	3600° \pm 10°
Standard terminal resistor (the higher value is always valid)	0.5 % or 1 Ω	0.5 % or 1 Ω	0.5 % or 1 Ω

Note: Characters highlighted in orange color are order features.

Pin assignment



Potentiometric outputs P01, P05, P10

Signal	Terminal
Po	11
Pe	13
S	12

Transducer MWI

Signal	Terminal
I+	12
I-	11
N.C.	13

Switching cam

Assignment	Switching cam 1 Terminal	Switching cam 2 Terminal	Switching cam 3 Terminal
	1	4	7
	2	5	8
	3	6	9

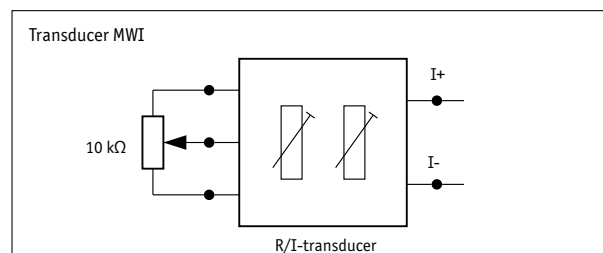
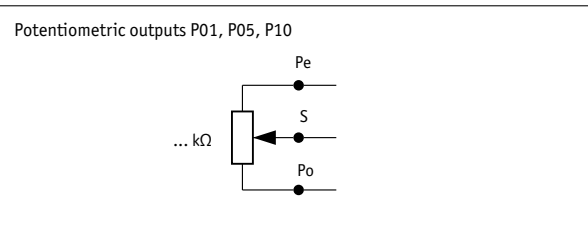

Order

Ratio calculation (order table, feature A)

$$\text{Formula: } i_1 = \frac{n \times 360^\circ}{\alpha}$$

n = number of revolutions on the driving shaft
 α = potentiometer angle of rotation
 340° with 1-coil potentiometer
 3600° with 10-coil potentiometer
 i1 = order feature for gear ratio

If the calculated ratio "i1" is the same as a value in the ordering table for the "ratio" feature, but this is not available, select the next highest ratio.

Switching cam order (example of order table, feature F)

Digit 1	Digit 2	Digit 3	Order data
cam form 2			2
cam form 1	cam form 3		13
cam form 1	cam form 2	cam form 3	123

! Order switching cams!
 1-3 switching cams can be ordered. Therefore, the order element can have 1 to 3 digits.

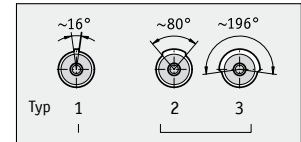

Switching angle of the 3 switching cams: specifically for end position limiter (1), for control functions (2, 3).

Order table

Feature	Order data	Specifications	Additional information
Gear ratio	... A	0.1/10, 0.1666/10, 0.2/10, 0.25/10, 0.333/10, 0.5/10, 0.5/2.5, 0.8/10, 1, 1.400, 1/3.0357, 2, 2.14, 2.5, 3, 3.333, 4, 5, 5.385, 6, 6.5, 7, 8, 10, 12, 12.25, 14, 15, 20, 21, 24, 25, 30, 33, 35, 40, 48, 55, 60.5, 64, 65.154, 70, 80, 96, 101.5, 121, 134.75, 150, 256, 348.8, 384, 463.830, 512 others on request	
Potentiometer type	01 B 02 03 03/0,1	1 coil, hybrid 10 coils, wire 10 coils, hybrid 10 coils, hybrid, linear tolerance ±0,1 %	
Resistance	P01 C P05 P10	potentiometer 1 kΩ potentiometer 5 kΩ potentiometer 10 kΩ	
Transducer	MWI D OMW	transducer 4 ... 20 mA without	only with P10 and potentiometer type 02 or 03
Sense of rotation	ODR E e i	without indication of sense of rotation counter-clockwise ascending values clockwise ascending values	with P01, P05 or P10 with MWI with MWI or MWU
Switching cam/form	... F	1, 2, 3, 11, 12, 13, 22, 23, 33, 111, 112, 113, 122, 123, 221, 222, 223, 233, 331, 333 others on request	
Operating voltage of switching cam	1 G 2	above 48 V dielectric strength up to 48 V dielectric strength	

Order code



Scope of delivery: GP43, User information

Accessories:

Self-aligning coupling
 Electronic display MA50

Page 112
 Page 92

Additional information:

General information and areas of application

Page 64 cont.